



PRO SERIES

USER MANUAL

FOR THE

PS 278

DUAL CHANNEL MASTER STATION



CONTENTS

1.0	GENERAL DESCRIPTION	1
2.0	UNPACKING	1
3.0	MECHANICAL INSTALLATION	1
4.0	MAINS POWER	2
5.0	FRONT PANEL CONTROLS	4
6.0	REAR PANEL CONTROLS AND CONNECTORS	6
7.0	INTERNAL CONTROLS	7
8.0	CABLING	8
9.0	PARTY LINE, TECHNICAL CONCEPT	9
10.0	GUARANTEE	9
11.0	DESIGN CRITERIA	9
12.0	TECHNICAL SPECIFICATIONS	10



1.0 GENERAL DESCRIPTION

The PS 278 is designed to be a master unit in an ASL intercom system and can be used in portable as well as fixed applications. It incorporates a dual channel intercom line power supply, a dual channel headset station, an audio input and uses only 1U of 19" rack space.

This makes the PS 278 very versatile and ideal for use in applications where standard microphone cable is available and ease of setup is of paramount importance.

Each channel has a Volume (listen level) control, a Talk and a Call button with LED indicators and a sidetone trimmer.

The intercom line power supply is fully protected and can drive at least 20 beltpacks or 10 speaker stations, or a combination, operating at full power. The power supply is completely separated from all other functions and in case of power failure the unit can accept line power from an external ASL power supply.

Since the power supply provides the line impedance, only one PS 278 should be used on the two channels. For driving more beltpacks/speaker stations on these lines an additional power supply booster (PS 285) is needed.

Special attention has been paid to the intelligibility of speech. By applying low noise/high speed circuitry, a speech presence filter and a specially designed high power headphone amplifier, communication is very comfortable even in environments with a high background noise level.

The unique ASL CALL system provides both a flashing red LED and a very distinctive and characteristic sound signal. Only a slight touch of the CALL button will make the LED flash, whilst holding the button for two seconds will activate the call sound signal. In case the sound signal is undesirable, all buzzers can be muted with the front panel 'all buzzers on/off' button.

Fully electronic switching increases reliability and allows for :

- 'soft' microphone ON switching, latched or momentary
- remote Mic Mute facility. All microphones of stations connected to the PS 278 can be muted by pushing a single front panel button.

An Aux input on the rear panel, allows injecting external audio signals of line or mic level. When 'mic level' is selected, +30 V phantom power is available at the Aux input connector.

An Aux signal can be routed to intercom line A and/or B, or directly to the local headset.

As an option, a XLR-6 headset connector can be fitted, allowing the user to hear channel A + AUX program signal on the left headset can and channel B + AUX program signal on the right headset can. By changing the position of internally mounted jumpers, it's also possible to hear channel A + B on the left can and the AUX program signal on the right can.

2.0 UNPACKING

The shipping carton contains the parts listed below.

- * The PS 278
- * Power cable
- * Spare fuses
- * User manual

If any are missing contact your dealer.

With the PS 278 will be a small packet of spare fuses. Please keep them in a safe place. There is also one spare fuse included in the mains inlet.

ASL has taken great care to ensure that this product reaches you in flawless condition.

After unpacking the unit please inspect for any physical damage to the unit, and retain the shipping carton and relevant packing materials for use should the unit need returning.

If any damage has occurred, please notify your dealer immediately so that a written claim can be initiated. Please also refer to the guarantee section of this manual.

3.0 MECHANICAL INSTALLATION

A vertical rack space of 1U (1.75", 44mm) is required for the PS 278. It is not necessary to provide rear support by extra bracing or shelving.

Adequate ventilation must be provided by allowing sufficient space around the sides and rear of the unit to ensure free circulation of air. Forced cooling is not

required.

The power supply regulator is mounted on the rear of the unit, and after a period of time it will feel hot to the touch. This is quite normal, and should be no cause for alarm.

4.0 MAINS POWER

The PS 278 may be connected to the mains power outlet to which other audio equipment is connected. The outlet should have a clean safety earth. Avoid using mains power outlets which also power dimmer controlled lighting equipment.

Before connecting the unit to its AC power source, check if the mains voltage setting is set in accordance with your local mains voltage. The voltage setting is indicated by a label on the rear panel.

If a change is necessary, the internal mains transformer wiring will need to be reconnected as shown in section 4.3 Mains Power settings.

Remember that the AC mains fuse will need to be changed for one of the correct rating as indicated.

The power cord supplied with this unit carries the following information label:

WARNING
This appliance must be earthed

IMPORTANT

The wires in this mains lead are colour coded in accordance with the following code:

green and yellow	Earth / safety ground
blue	
	Neutral
brown	
	Live

As the colours of the wires in the mains lead may not correspond with the coloured markings identifying the terminals in your plug, proceed as follows:

- The wire which is coloured green-and-yellow must be connected to the terminal in the plug which is marked with the letter "E", or by the earth symbol which is \perp or coloured green.
- The wire which is coloured blue must be connected to the terminal which is marked with the letter "N" or coloured black.
- The wire which is coloured brown must be connected to the terminal which is marked with the letter "L" or coloured red.

Those units that are supplied to the North American market will have an integral moulded 3 pin connector which is provided to satisfy required local standards.

4.1 SAFETY EARTHING

The green-and-yellow wire of the mains cord must always be connected to the electrical installation safety earth or ground. It is essential for personal safety as well for proper operation of the PS 278 and the other connected stations. This wire is internally connected to all exposed metal surfaces and any rack framework into which this unit might be mounted is assumed to be connected to the same grounding circuit.

The PS 278 employs professionally designed audio input and output circuits which do not require the disconnection of any safety earth for the avoidance of hum loops.

4.2 POWERING UP

Powering up procedure:

- Make sure that the red power switch on the left side of the front panel is OFF.
- Connect the power cord to the rear of the station.
- Plug the other end of the power cord into a PROPERLY GROUNDED outlet.
- Turn on the power with the red button. The red overload LED will light up for about 3 seconds, then extinguish and then the green power LED will go on, indicating that the station is active.

4.3 MAINS POWER SETTING

Voltage settings (Top View)

See also section 4.0 Mains Power

Setting for 115 V AC Voltage:

1. Red + Green
2. Empty
3. White + Yellow

Setting for 230 V AC Voltage:

1. Red
2. White + Green
3. Yellow

Mains Fuse

100 - 120V T 630 mA
220 - 240V T 315 mA

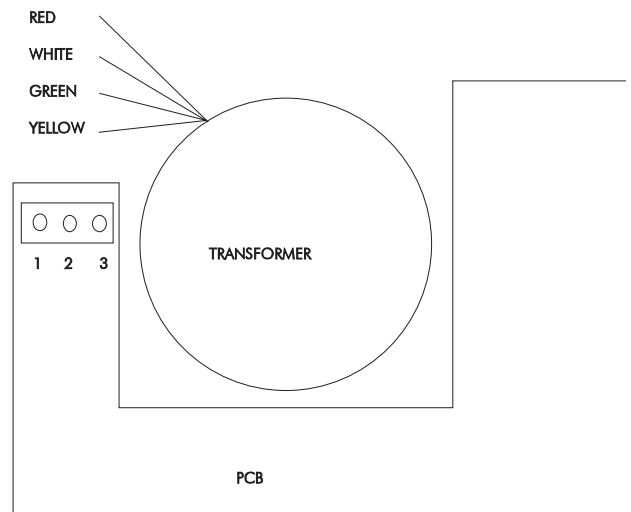

5.0 FRONT PANEL CONTROLS

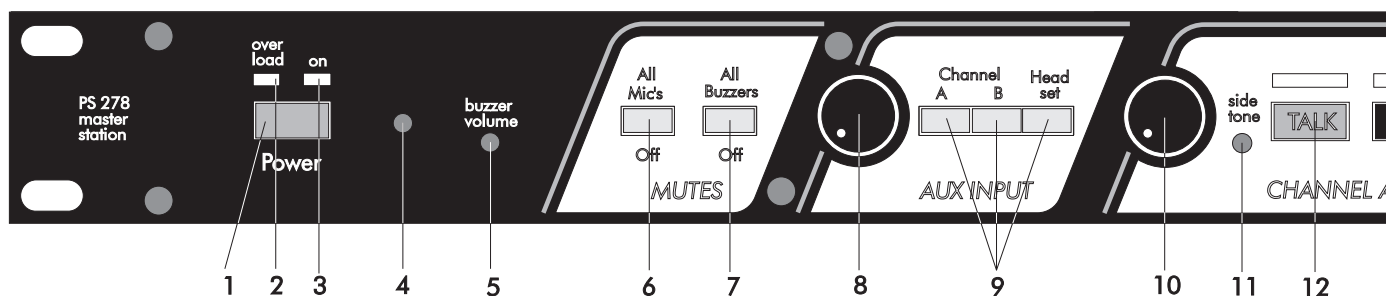

1 POWER ON/OFF switch

Mains power push button for switching ON and OFF the internal power supply.

2 OVERLOAD LED

This LED illuminates if the internal power supply has shut off line power due to overload. If the internal power supply is overloaded (too many user stations are connected, or short-circuit in the interconnecting cables, or thermal overload), it activates a circuit-breaker which immediately shuts off line power. This circuit breaker resets automatically 3 seconds after the overload situation is terminated, restoring line power automatically. During short-circuit, the LED will flash every 3 seconds. During thermal overload it will remain on continuously. The LED will also come on for a few seconds every time you switch on the mains power.

3 POWER LED

This LED illuminates if line power is supplied by the internal power supply.

4 BUZZER

This buzzer indicates an incoming or outgoing call. It is activated by pressing a CALL button of the PS 278 or a CALL button of any other station on channel A or B for longer than two seconds and the buzzers are not muted (see 5.7). You can adjust its volume with the buzzer volume control.

5 BUZZER VOLUME trimmer

This trimmer adjusts the volume of the buzzer.

6 ALL MIC'S ON/OFF button

With this pushbutton all microphones of the connected stations can be muted.

7 ALL BUZZERS ON/OFF button

With this button all buzzers of the connected stations can be muted.

8 AUX VOLUME control knob

This knob adjusts the level of the aux input signal before it is sent either to the intercom line(s) or to the headset (see also section 5.8).

9 A/B/HEADSET routing switches

These three switches route the aux input signal to either:

- 1) Intercom channel A and/or Intercom channel B
- 2) Directly to the headset

If the aux is routed to the headset the aux is for local monitoring only, and can not be routed to the intercom channels.

5.0 FRONT PANEL CONTROLS

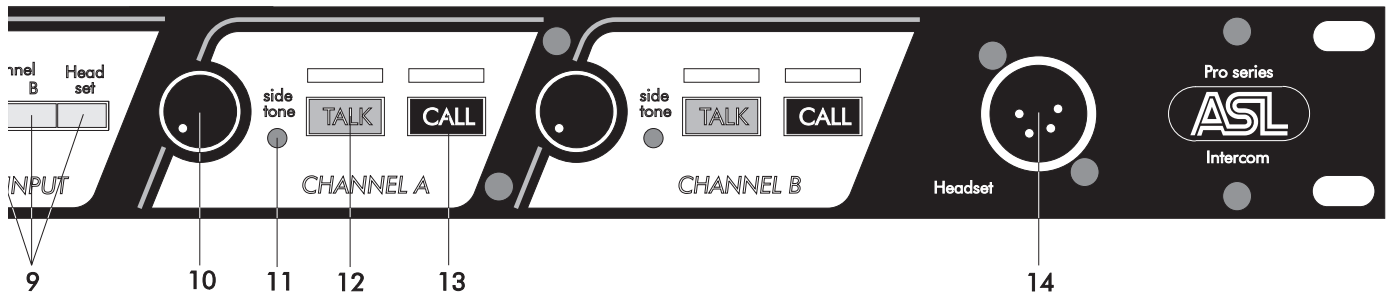

10 VOLUME control knobs

These knobs adjust the listen level for the headset. Each channel can be adjusted separately.

11 SIDETONE trimmers

These trimmers adjust the level of your own voice as you hear it in your headset.

Adjustment procedure :

- set the trimmer in start position: fully clockwise.
- switch off the microphone of all connected (speaker!) stations.
- switch on the microphone of the required channel.
- turn up the volume of the required channel.
- speak into the headset microphone.
- adjust the listen level by turning the sidetone trimmer.

The operating area is between fully clockwise and minimum level. Adjusting the sidetone does not affect the level of your voice as it is heard by other stations.

12 TALK buttons

These buttons allow you to talk to each channel separately or simultaneously.

The large green LED indicates if the talk function is activated.

Latched switching:

When a TALK button is momentarily pressed, the microphone will be switched on for the chosen channel and is electronically latched. When pressed again, the microphone will be switched off.

Momentary switching:

When a TALK button is pressed and held, the microphone will be switched on, and when released, will be switched off.

13 CALL A & B buttons

These push buttons activate the CALL system.

A momentary push will send a CALL signal to all stations connected to that intercom channel and the CALL LEDs will start flashing.

Press and hold the buttons for 2 seconds will activate the call buzzer, if not muted.

After the CALL button is released the LEDs will continue to flash for a further 2 seconds.

14 HEADSET connector

A XLR-4 type connector for the connection of the local headset. This must have a can impedance of 200 ohms (or greater), or each 400 ohms minimum when in parallel. The mic may be of the dynamic or electret type.

Pin assignments:

1. shield mic. (GND)
2. mic. +
3. phones +
4. phones -

The wiring is such that both headset cans are connected in parallel and receive the same signal. The two headphone amplifiers run in a bridged mode.

As an option, a XLR-6 type connector can be fitted to give a binaural headset configuration where a different signal will appear on each can. In this mode the internal headphone amplifiers are not bridged. See section 7.1 Internal Jumpers and Controls.

6.0 REAR PANEL CONTROLS & CONNECTORS

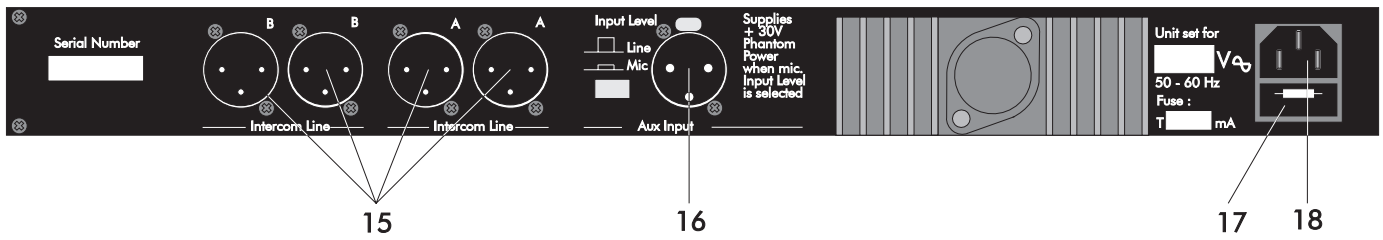

15 A & B LINE connectors

These XLR-3 type connectors are for connecting the remote-stations, via standard microphone cable. There are two connectors for channel A and two connectors for channel B.

Pin assignments :

1. 0 V / ground shield
2. +30 V power wire
3. audio wire

16 AUX INPUT connector

This XLR-3 type aux input is electronically balanced and accepts audio levels between -18dBu to +22dBu on line level, and -38dBu to +2dBu on mic level.

Pin assignments :

1. 0 V / ground
2. Signal +
3. Signal -

When mic level is selected, a +30Vdc phantom power is supplied to pins 2 and 3.

17 FUSE

This fuse protects the PS 278 against severe internal damage, in case of malfunction in the power section. To remove the fuse the mains cord must be removed. It is most important to place the correct fuse in the holder :

mains voltage	fuse
220 - 240 VAC	T 315 mA
100 - 120 VAC	T 630 mA

Spare fuses will be found in the small packet supplied with the unit.

18 MAINS INLET

IEC Mains connector. For correct wiring and operation refer to section 4.0.

WARNING

Before you plug in the mains voltage, check if:

- The fuse is correct
- The voltage is correct

7.0 INTERNAL CONTROLS

MIC GAIN

The mic gain can be adjusted internally.

- Open the PS 278 with the two top screws at the frontpanel and the two screws top side

The trimmer is located at the right front of the unit.

To increase mic gain turn clockwise.
To decrease mic gain turn counterclockwise.

See section 7.1 for the location of the mic gain trimmer.

7.1 INTERNAL JUMPER SETTINGS AND CONTROLS

Binaural Jumper settings

See also section 5.0 -14 HEADSET connector

The binaural configuration is set by internal jumpers J3, as follows:

Jumpers in position A

Left can channel A and B.
Right can AUX-signal.

Jumpers in position B

Left can channel A and AUX-signal.
Right can channel B and AUX-signal.

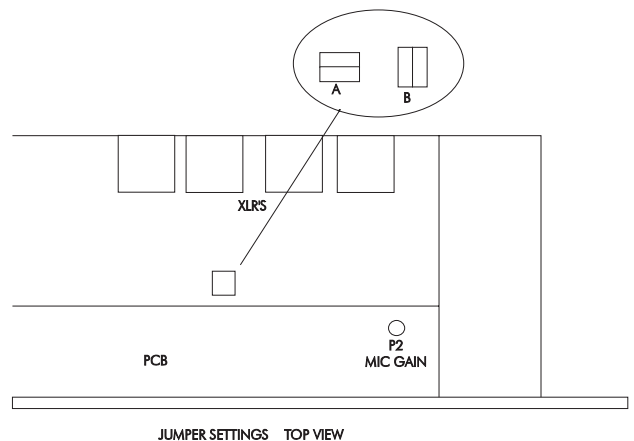

Internal mic gain

See also section 7.0 - Internal Controls

The mic gain trimmer is labeled:
P2 for the mic gain setting.

8.0 CABLING

For the PRO Series Intercom system the interconnecting cables are of the shielded two-conductor microphone cable type and the intercom line connectors are of the XLR-3 type. Audio and Call signals are on XLR pin 3, DC power is on XLR pin 2. XLR pin 1 is connected to the shield of the cable which functions as the common return for audio and power.

Since the audio signal is transferred in an **unbalanced** ★ way, certain rules have to be obeyed when installing the cables of an intercom network. This is to avoid earth loops and to minimize power loss and the possible effect of electromagnetic fields.

These rules are:

- **Use high quality (multipair) cable.**
For interconnecting user stations, power supplies and accessories in an ASL Intercom network, use high quality shielded two-conductor (minimum 2x 0.30 mm²) microphone cable only.
In case of a multi channel intercom network, use high quality microphone 'multipair' cable only, each pair consisting of two conductors (minimum 2x 0.15 mm²) with separate shield. Multipair cable should also have an overall shield.
 - **Use flexible cables.**
Use flexible single and multipair microphone cable instead of cable with solid cores, especially when the cable is subjected to bending during operation or installation.
 - **Separate cable screen to XLR pin 1.**
The screen of each separate microphone cable and/or the screen of each single pair in a multipair cable, should be connected to pin 1 of each XLR-3 connector. Do not connect this cable screen to the metal housing of the connector or to metal wall boxes (outlets). See page 13 for Earthing Concept.
 - **Cable trunks, connection boxes and overall multipair cable screen to clean earth.**
Metal cable trunks, metal connection boxes and overall multipair cable screen should be interconnected and, at one point (the 'central earthing point') in the intercom network only, be connected to a clean safety earth. See page 13 for Earthing Concept.
 - **Keep metal connection boxes and cable trunks isolated from other metal parts.**
Metal housings for intercom cables and connectors should be mounted in such a way that they are isolated from other metal cable and connector housings and from any other metal construction parts.
- ★ **See Party Line, Technical Concept**
- **Keep cables parallel as much as possible**
When two (multi channel) units in a network are connected by more than one cable, make sure that these cables are parallel to each other over the whole distance between those units. When using multipair cable, parallelism is ensured in the best possible way.
 - **Avoid closed loops.**
Always avoid that cables are making a loop. So-called 'ring intercom' should not physically be cabled as a ring. All cable routes should have a 'star' configuration, with the central earthing point (usually close to the power supply position) as the centre of the star.
 - **Keep cables away from electromagnetic sources.**
Keep intercom cables away from high energy cables, e.g. 110/220/380V mains power or dimmer controlled feeds for spotlights.
Intercom cables should cross high energy cables at an angle of 90° only.
Intercom cables should never be in the same trunking as energy cables.
 - **Place power supplies in a central position.**
In order to avoid unacceptable power losses, place the power supplies as close as possible to where most power consumption occurs or, in other words, most user stations are placed.
 - **Connect ASL power supply to a 'clean' mains outlet.**
The ASL power supply may be connected to the mains power outlet to which other audio equipment is connected. Avoid using mains outlets which also power dimmer controlled lighting systems.
- In case of more complex installations, don't hesitate to contact us. Please send us a block diagram of the planned network with a list of all user stations and their positions, and we are happy to advise you on cabling lay-out.

9.0 PARTY LINE, TECHNICAL CONCEPT

ASL's PRO Series offers a complete two way ('full duplex') communications system.

Users of the system are connected via a 'party line'.

Master stations (with built-in power supply), beltacks, speaker stations and power supplies are interconnected via standard microphone cable. One wire is used as an audio line, one as a power line and the screen of the cable functions as earth/return.

Current drive is used for signal transfer. Each station utilises a current amplifier to amplify the microphone signal and place it on the common audio line where, due to the constant line impedance (situated in the power supply between XLR pin 3 and 1), a signal voltage is developed which can be further amplified and sent to headphones or loudspeakers.

This principle has three advantages:

- the use of a single audio line allows several stations to talk and listen simultaneously.
- due to the high bridging impedance offered by each station, the number of stations 'on line' has no influence on the level of the communications signal.
- power and audio to the intercom stations use the same cable.

The Call signal is also sent as a current on the audio line. It develops a DC potential over the line impedance which will be sensed by each station and interpreted as a Call signal.

10.0 GUARANTEE

This unit is warranted by ASL Intercom to the original end-user purchaser against defects in workmanship and materials in its manufacture for a period of one year from the date of shipment to the end-user.

Faults arising from misuse, unauthorised modifications or accidents are not covered by this warranty. If the unit is faulty, it should be sent in its original packing to the supplier or your local ASL dealer, with shipping prepaid. A note must be included stating the faults found and a copy of the original suppliers invoice.

11.0 DESIGN CRITERIA

Applications / Environment of use

ASL Pro Series equipment is designed for use as a wired communications system in theatres, in Radio/TV production facilities, in factories, and in utilities complexes such as airports, railway stations and coach terminals.

ASL equipment can be used outdoors in normal weather conditions. In conditions with excessive cold ($<-10^{\circ}\text{C}$), heat ($>50^{\circ}\text{C}$) or humidity ($>85\%$), ASL equipment might not perform properly.

ASL equipment is not designed to be used under water, or in situations where explosion safe equipment is specified by authorities.

Emission

ASL Pro Series equipment does not generate high frequency (HF) signals. An ASL power supply can generate a weak magnetic field caused by the power transformer. To avoid possible negative effects, keep ASL power supplies at a safe distance from equipment which is very sensitive to magnetic fields.

Immunity

ASL Pro Series is designed on the base of low impedance signal transport. User stations and power supplies are to be connected via low capacity cabling with an overall screen (see also Cabling section). Therefore, HF signals are adequately rejected to maintain an intelligible communication, unless strong electro-magnetic fields (exceeding 3V/m) are in the direct vicinity of the interconnecting cables.

ASL 19" rackmount units are housed in a 1 mm steel enclosure (closed construction), which offers, by nature, the highest possible rejection of electro-magnetic fields.

ASL speaker stations (PS 130/230/430) are housed in an enclosure made of 1 mm steel with ABS side panels, which offers adequate rejection of electro-magnetic fields.

ASL beltacks are housed in an ABS enclosure and are slightly more sensitive to electro-magnetic fields. Negative effects in the performance of beltacks can be avoided when keeping them on a safe distance from equipment which might radiate strong electro-magnetic fields, such as transmitter antennas and dimmers.

THIS PRODUCT WAS DESIGNED, DEVELOPED AND MANUFACTURED BY :

**AMPCO SOUND LAB BV
MAARSSSEN (UTRECHT) HOLLAND**

12.0 TECHNICAL SPECIFICATIONS PS 278

POWER SUPPLY

mains voltage range	115 V units: 100 - 125 V 60Hz AC 230 V units: 210 - 250 V 50Hz AC
DC output voltage	+30 V +/-5% DC
ripple and noise	< 11 mV rms
max. output current	1.7 A continuous / 3 A peak
circuit-breaker delay time	0.2 sec.
automatic reset time	3.0 sec.

AUX INPUT

input impedance	30 Kohms (balanced line level) 4.6 Kohms (balanced mic level)
nominal input level	-18 dBu to +6 dBu (line level) -38 dBu to -14 dBu (mic level)
max. input level	+22 dBu (line level) +2 dBu (mic level)
phantom power	+30 V DC (mic level selected)

MIC. PREAMP

mic. impedance	200 ohms
gain	40 dB - 70 dB (adjustable internally)
presence filter	+6 dB at 5 kHz
frequency response	200 Hz - 13 kHz (-6 dB)
V electret mic	+ 9 V DC

HEADPHONES DRIVER AMP

max. load	200 ohms
max. output level	normal 14 V rms (200 ohms) binaural 8 V rms (400 ohms)
max. output power	normal 0.5 W rms (each can) binaural 0.16 W rms (each can)

SIDETONE

rejection	0 - 30 dB adjustable
-----------	----------------------

BUZZER

max. SPL	100 dBA
----------	---------

DIMENSIONS AND WEIGHT

width	19" (483 mm)
height	1U (44.5 mm)
depth	150 mm
weight	2.75 Kg

GENERAL SYSTEM SPECIFICATIONS

intercom line impedance	350 ohms (1kHz) 2.2 Kohms (DC)
intercom line audio level	nom. -18 dBu max. +4 dBu
dynamic range	80 dB
call send signal	2.8 mA
call receive signal threshold	+2.4 V DC
supply voltage	+30 V DC (12 V to 32 V)
mic mute power interrupt time	0.1 sec

Note: 0 dBu = 775 mV into open circuit.

ASL reserves the right to alter specifications without further notice.

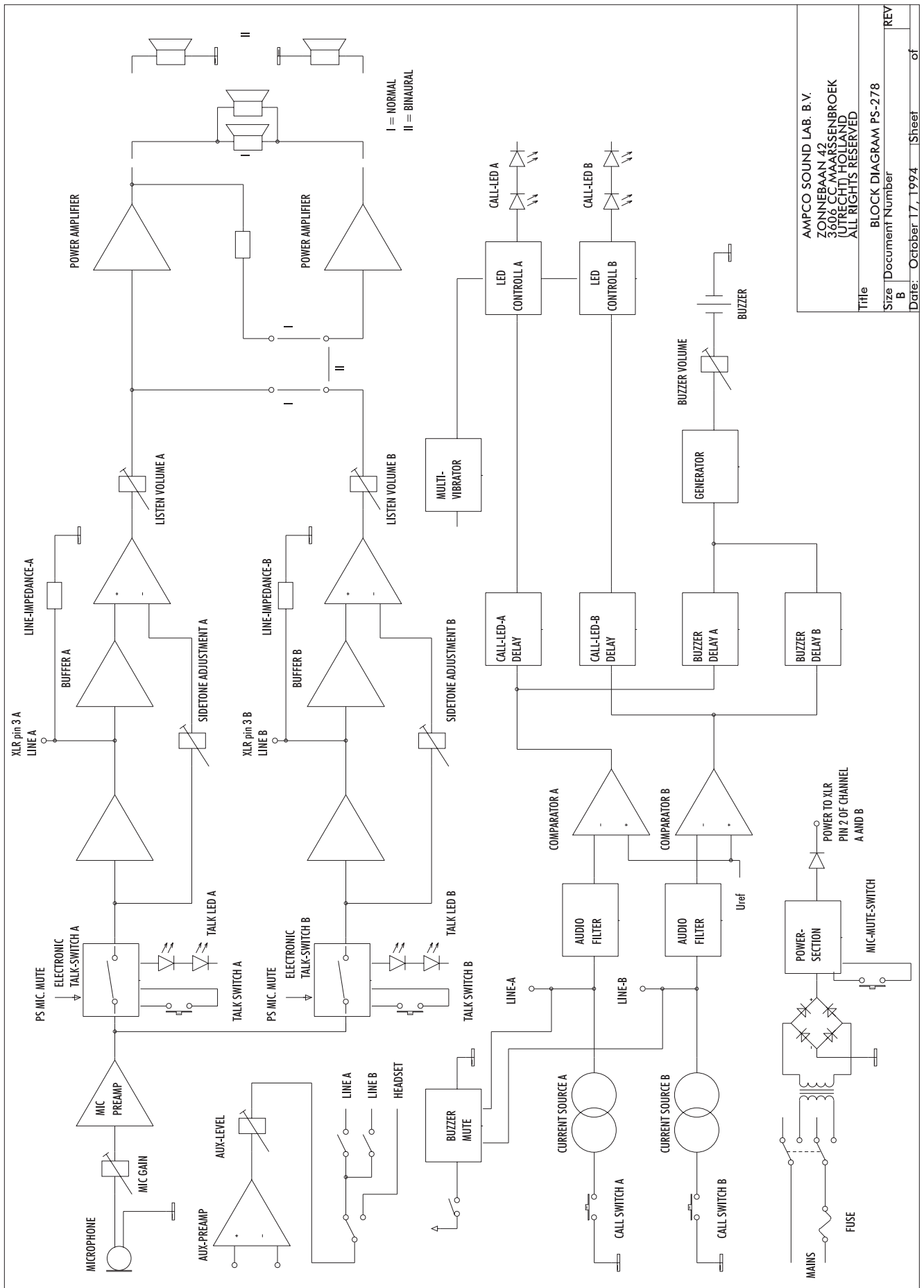

AMPCO SOUND LAB. B.V.
 ZONNEBAAN 42
 3606 CC WAARSSENBROEK
 UTRECHT, HOLLAND
 ALL RIGHTS RESERVED

Title: BLOCK DIAGRAM PS-278
 Size: Document Number B
 Date: October 17, 1994 Sheet of

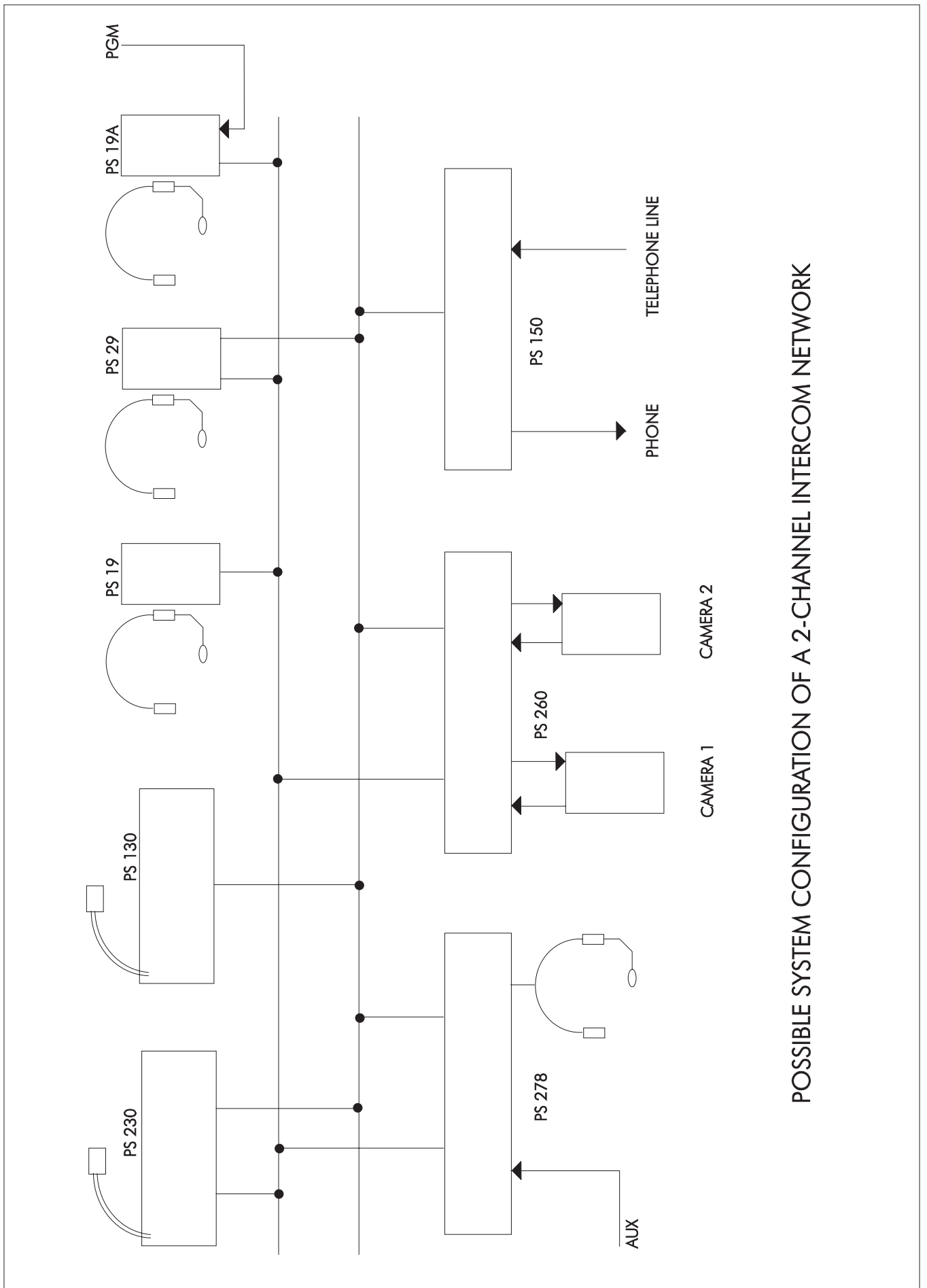

POSSIBLE SYSTEM CONFIGURATION OF A 2-CHANNEL INTERCOM NETWORK

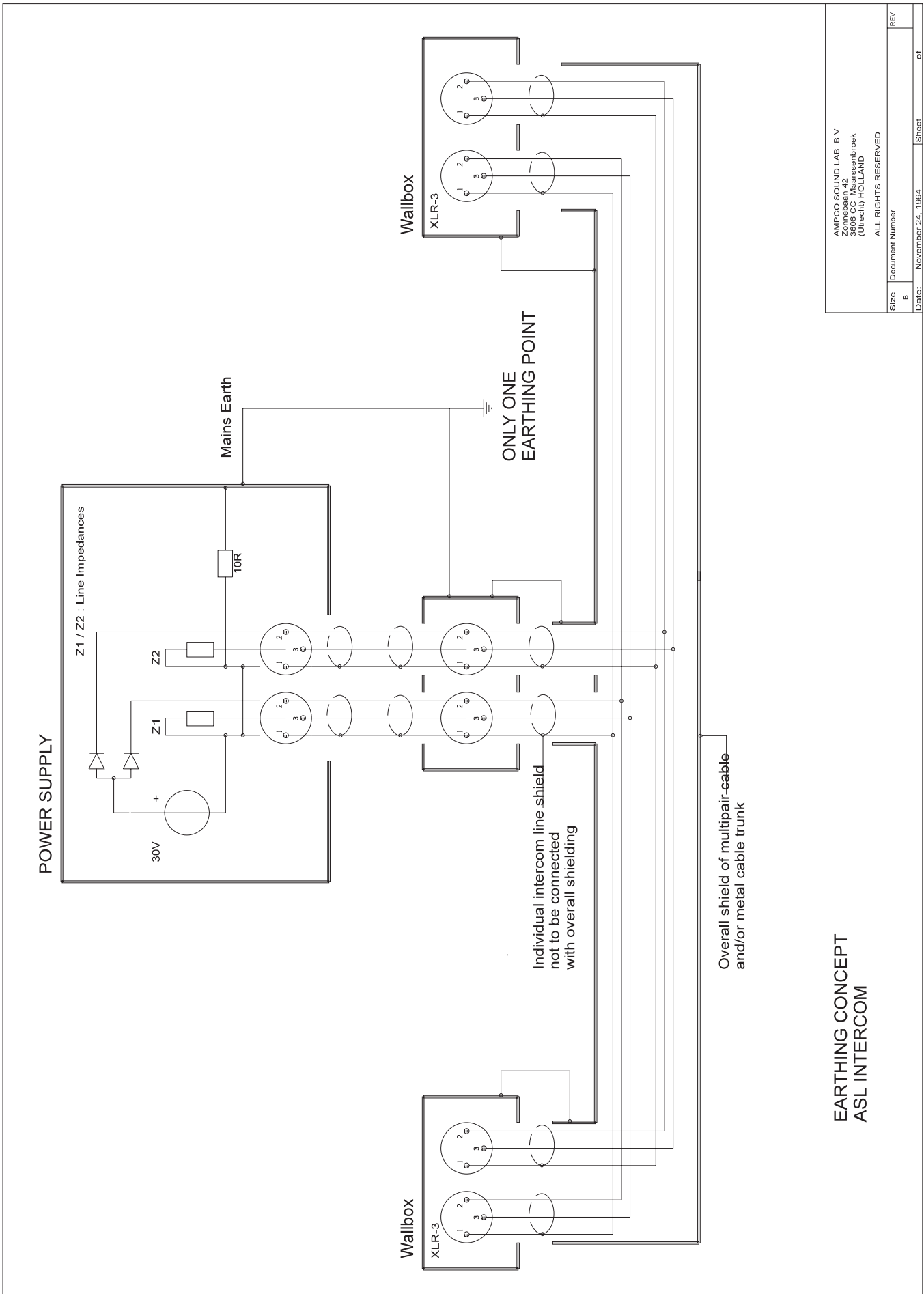

**EARTHING CONCEPT
ASL INTERCOM**

AMPCO SOUND LAB. B.V.
Zonnebaan 42
3806 CC Maarssenbroek
(Utrecht), HOLLAND
ALL RIGHTS RESERVED

Size	Document Number	REV
B		
Date:	November 24, 1994	Sheet
		of

