

LED Matrix Blinder
5x5 DMX
blinder

Musikhaus Thomann e.K.

Treppendorf 30

96138 Burgebrach

Germany

Telephone: +49 (0) 9546 9223-0

E-mail: info@thomann.de

Internet: www.thomann.de

20.12.2013, ID: 278014

Table of contents

1	General notes	5
2	Safety instructions	8
3	Features	12
4	Installation	13
5	Starting up	15
6	Connections and operating elements	18
7	Operating	24
	7.1 Starting the device.....	24
	7.2 Main menu.....	24
	7.3 Menu overview.....	29
	7.4 Functions in 1-channel DMX mode.....	30
	7.5 Functions in 4-channel DMX mode.....	31
	7.6 Functions in 26-channel DMX mode.....	32
	7.7 Functions in 28-channel DMX mode.....	33
	7.8 Temperature monitoring.....	35

8	Technical specifications.....	36
9	Plug and connection assignments.....	37
10	Troubleshooting.....	38
11	Cleaning.....	40
12	Protecting the environment.....	41

1 General notes

This user manual contains important information on safe operation of the device. Read and follow all safety notes and all instructions. Save this manual for future reference. Make sure that it is available to all persons using this device. If you sell the device, include the manual for the next owner.

Our products are subject to a process of continuous development. We therefore reserve the right to make changes without notice.

Symbols and signal words

This section provides an overview of the symbols and signal words used in this user manual.

Signal word	Meaning
DANGER!	This combination of symbol and signal word indicates an immediate dangerous situation that will result in death or serious injury if it is not avoided.
WARNING!	This combination of symbol and signal word indicates a possible dangerous situation that can result in death or serious injury if it is not avoided.
NOTICE!	This combination of symbol and signal word indicates a possible dangerous situation that can result in material and environmental damage if it is not avoided.
Warning signs	Type of danger
	Warning – high-voltage.

Warning signs	Type of danger
	Warning – danger zone.

2 Safety instructions

Intended use

This device is intended to be used as an electronic illumination effect using LED technics. Use the device only as described in this user manual. Any other use or use under other operating conditions is considered to be improper and may result in personal injury or property damage. No liability will be assumed for damages resulting from improper use.

This device may be used only by persons with sufficient physical, sensorial, and intellectual abilities and having corresponding knowledge and experience. Other persons may use this device only if they are supervised or instructed by a person who is responsible for their safety.

Safety



DANGER!

Danger for children

Ensure that plastic bags, packaging, etc. are disposed of properly and are not within reach of babies and young children. Choking hazard!

Ensure that children do not detach any small parts (e.g. knobs or the like) from the unit. They could swallow the pieces and choke!

Never let children unattended use electrical devices.



DANGER!

Electric shock caused by high voltages inside

Within the device there are areas where high voltages may be present. Never remove any covers.

There are no user-serviceable parts inside.



DANGER!

Electric shock caused by short-circuit

Always use proper ready-made insulated mains cabling (power cord) with a protective contact plug. Do not modify the mains cable or the plug. Failure to do so could result in electric shock/death or fire. If in doubt, seek advice from a registered electrician.



WARNING!

Eye damage caused by high light intensity

Never look directly into the light source.



WARNING!

Risk of epileptic shock

Strobe lighting can trigger seizures in photosensitive epilepsy. Sensitive persons should avoid looking at strobe lights.



NOTICE!

Risk of fire

Do not cover the device nor any ventilation slots. Do not place the device near any direct heat source. Keep the device away from naked flames.



NOTICE!

Operating conditions

This device has been designed for indoor use only. To prevent damage, never expose the device to any liquid or moisture. Avoid direct sunlight, heavy dirt, and strong vibrations.



NOTICE!

Power supply

Before connecting the device, ensure that the input voltage (AC outlet) matches the voltage rating of the device and that the AC outlet is protected by a residual current circuit breaker. Failure to do so could result in damage to the device and possibly injure the user.

Unplug the device before electrical storms occur and when it is unused for long periods of time to reduce the risk of electric shock or fire.

3 Features

The LED blinder is particularly suitable for lighting applications in clubs and discotheques, on rock stages, in theatres and musicals.

Special features of the device:

- 25 warm white LEDs (3 W each), arranged in a 5×5 matrix
- Control via DMX (four different modes) and via buttons and display on the unit
- 26 preprogrammed automatic shows
- LED matrix allows the display of letters and numbers
- Sound control
- Four master / slave modes for up to four interconnected devices that are controlled as one common large LED matrix
- Rugged metal housing with M6 thread holes for easy and stable interconnection of several units.

4 Installation

Unpack and carefully check that there is no transportation damage before using the unit. Keep the equipment packaging. To fully protect the device against vibration, dust and moisture during transportation or storage use the original packaging or your own packaging material suitable for transport or storage, respectively.



NOTICE!

Risk of overheating

Always ensure sufficient ventilation.

The ambient temperature must always be below 40 °C (104 °F).



NOTICE!

Use of stands

When mounting the device onto a stand, ensure that the stand is in a safe and stable position and that the weight of the device does not exceed the maximum permissible load capacity of the stand.



NOTICE!

Possible data transmission errors

For error-free operation make use of dedicated DMX cables and do not use ordinary microphone cables.

Never connect the DMX input or output to audio devices such as mixers or amplifiers.

5 Starting up

Establish all connections as long as the unit is switched off. Use the shortest possible high-quality cables for all connections.

Connections in DMX mode

Connect the DMX input of the device to the DMX output of a DMX controller or another DMX device. Connect the output of the first DMX device to the input of the second one, and so on to form a daisy chain. Always ensure that the output of the last DMX device in the daisy chain is terminated with a resistor ($110\ \Omega$, $\frac{1}{4}\text{ W}$).

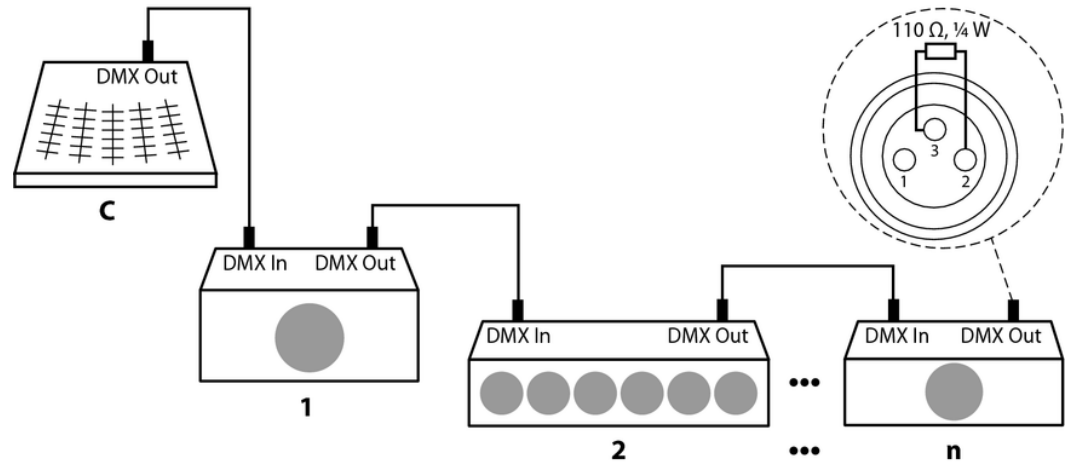

DMX indicator

If the unit is properly connected to a turned on DMX controller, the first position of the display is flashing in DMX mode. If not, the device is not receiving a valid DMX signal.

Connections in master/slave mode

When you configure a group of devices in master/slave mode, the first unit will control the other units for an automatic, sound-activated, synchronized show. This function is ideal when you want to start a show immediately. Connect the DMX output of the master device to the DMX input of the first slave device. Then connect the DMX output of the first slave device to the DMX input of the second slave device and so on.

6 Connections and operating elements

Rear panel

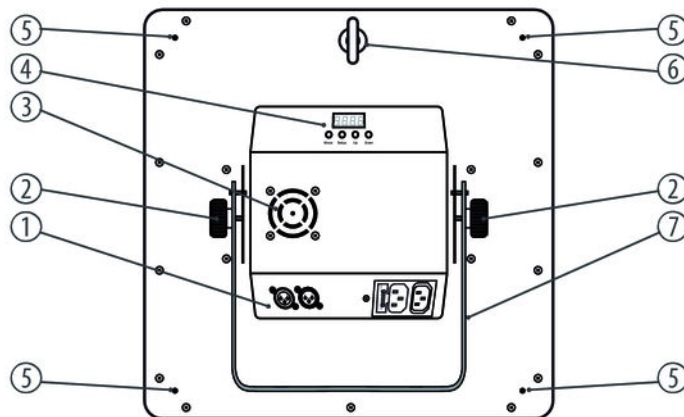

1	Connection panel.
2	Locking screws for the mounting bracket.
3	Fan.
4	Buttons and display.
5	Thread holes (M6), fit for connecting elements.
6	Safety eye.
7	Bracket for floor placement or hanging.

Connection panel

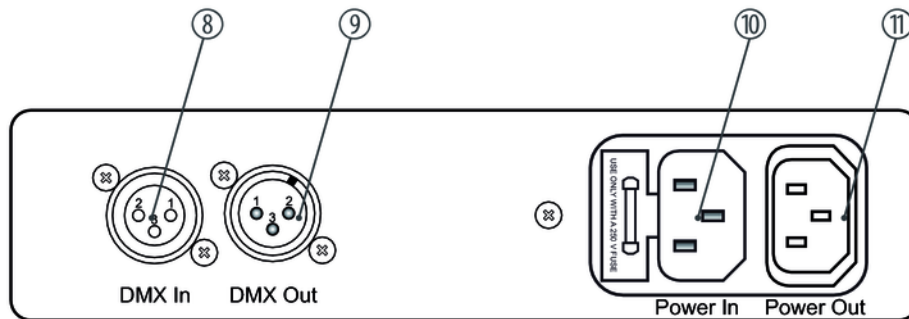

8	DMX In DMX input.
9	DMX Out DMX output.
10	Power In IEC chassis plug for operating voltage supply with fuse holder.
11	Power Out IEC chassis socket for the power supply cable to the next unit.

Buttons and display

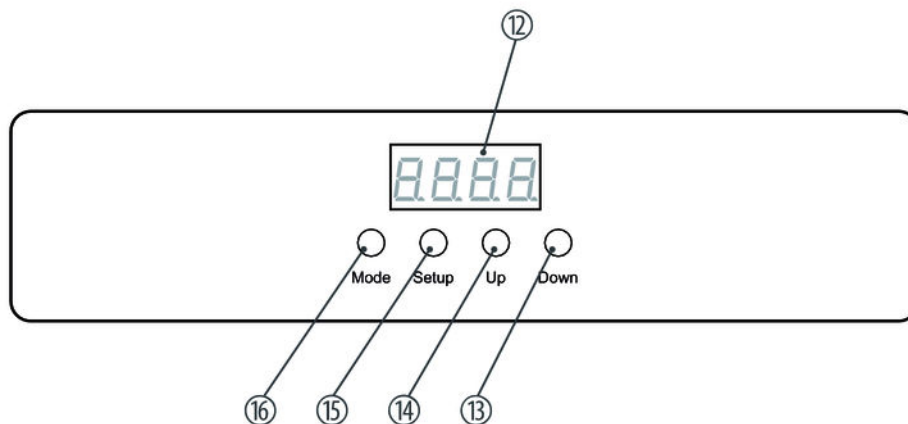

12	Display.
13	Button [<i>Down</i>] Decreases the displayed value by one.
14	Button [<i>Up</i>] Increases the displayed value by one.
15	Button [<i>Setup</i>] Selects an option of the respective operating mode, confirms the set value.
16	Button [<i>Mode</i>] Activates the main menu and toggles between menu items. Closes an opened submenu.

7 Operating

7.1 Starting the device

Connect the device to the power supply to start operation. After a few seconds, the display indicates that a reset is in progress. The device is then ready for use. The display shows the operating mode that was selected when the unit was last powered off.

7.2 Main menu

Press *[Mode]* to activate the main menu and select an operating mode. Use *[Setup]* to select further options. Use *[Up]* and *[Down]* to change the respectively displayed value. The unit instantly applies the displayed value, you don't need to push a button for confirmation.

If you don't press any button for about ten seconds the display turns off. It will be reactivated to display the previously shown menu by pressing any button.

The set values are retained even when the device is disconnected from the mains power supply. To delete all settings made by you, follow the notes in chapter [↪ 'Reset to factory defaults' on page 28](#).

Operating mode 'Preprogrammed automatic show'

Press *[Mode]* repeatedly until the display shows 'Pr.xx'. Now you can select one of the preprogrammed automatic shows. Use *[Up]* and *[Down]* to select a value between 'Pr.01' and 'Pr.26'.

To adjust the programme speed, press *[Setup]*. The display shows 'SP.xx'. Now use *[Up]* and *[Down]* to select a value between 'SP.01' (slow) and 'SP.FL' (fast).

To adjust the strobe frequency, press *[Setup]* again. The display shows 'FS.00'. Now use *[Up]* and *[Down]* to select a value between 'FS.00' (slow) and 'FS.99' (fast).

DMX mode

Press *[Mode]* repeatedly until the display shows 'dxxx'.

Now you can set the number of the first DMX channel to be used by the device (DMX address). Use *[Up]* and *[Down]* to select a value between 1 and 512 (display shows 'd001' ... 'd512').

Make sure that this number matches the configuration of your DMX controller. The following table shows the highest possible DMX address for the various DMX modes

Mode	Highest possible DMX address
1-channel	512
4-channel	509
26-channel	487
28-channel	485

Press *[Setup]*. Now use *[Up]* and *[Down]* to select one of the following DMX operating modes:

- '1-ch' (one channel)
- '4-ch' (four channels)
- '26ch' (26 channels)
- '28ch' (28 channels)

Operating mode 'Slave'

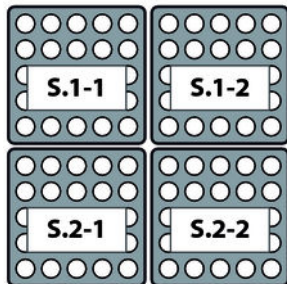

In the master-slave configuration, you can interconnect four devices of the same type to one large matrix with 10×10 LEDs. The effects then use this device combination in common.

Press *[Mode]* repeatedly until the display shows 'SLAv'.

Press *[Setup]*. With *[Up]* and *[Down]* you can now set the position at which the particular device is located within the equipment combination. The figure alongside shows the possible values and their meaning. Unit 'S.1-1' works as Master.

Sound control

Press *[Mode]* repeatedly until the display shows 'Soud'. This activates the sound-controlled automatic show.

Press *[Setup]* and use *[Up]* and *[Down]* to adjust the sensitivity for the sound control in a range from 'SU.00' (low sensitivity) to 'SU.31' (high sensitivity).

Display of letters and numbers

Press *[Mode]* repeatedly until the display shows 'ChAr'. Press *[Setup]*. With *[Up]* and *[Down]* you can now select between the display of letters (display shows 'Lett') and the display of numbers (display shows 'nUbe'). Press *[Setup]* again and use *[Up]* and *[Down]* to select the letter or the number to be displayed.

Testing the LED matrix

Press *[Mode]* repeatedly until the display shows 'TEST'. Now all LEDs of the matrix light up.

Operating mode 'Automatic'

Press *[Mode]* repeatedly until the display shows 'AUTO'. The playback of the random show starts automatically.

Reset to factory defaults

To reset all settings you have made to factory defaults, press *[Mode]* and *[Setup]* simultaneously for five seconds. After the reset, the unit operates in automatic mode and the display shows 'AUTO'.

7.3 Menu overview

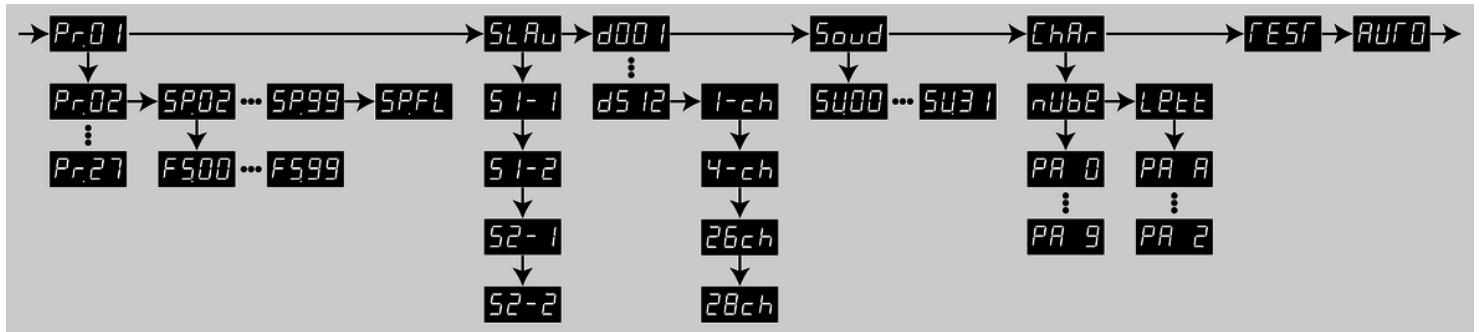

7.4 Functions in 1-channel DMX mode

Channel	Value	Function
1	0...255	Dimmer (0 % to 100 %), for all LEDs together

7.5 Functions in 4-channel DMX mode

Channel	Value	Function
1	0...255	Dimmer (0 % to 100 %), for all LEDs together
2	Operating mode	
	0	LEDs off
	1...11	Preprogrammed automatic show no. 1
	12...23	Preprogrammed automatic show no. 2
		⋮
	240...251	Preprogrammed automatic show no. 21
	252...255	Sound-controlled show
3	0...255	Increasing speed
4	0...255	Strobe effect, increasing speed

7.6 Functions in 26-channel DMX mode

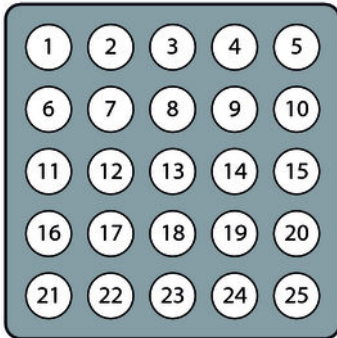

The figure alongside shows the numbering of the LEDs.

Channel	Value	Function
1	0...255	Dimmer (0 % to 100 %), for all LEDs together
2	0...255	Dimmer (0 % to 100 %), for LED no. 1
3	0...255	Dimmer (0 % to 100 %), for LED no. 2
		⋮
26	0...255	Dimmer (0 % to 100 %), for LED no. 25

7.7 Functions in 28-channel DMX mode

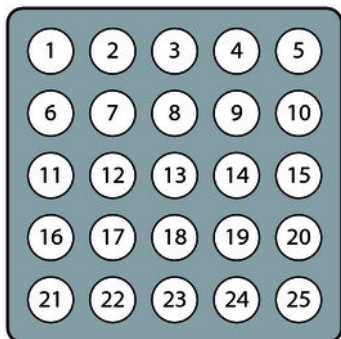

The figure alongside shows the numbering of the LEDs.

Channel	Value	Function
1	0...255	Dimmer (0 % to 100 %), for all LEDs together
2	0...255	Dimmer (0 % to 100 %), for LED no. 1
3	0...255	Dimmer (0 % to 100 %), for LED no. 2
		⋮
26	0...255	Dimmer (0 % to 100 %), for LED no. 25
27	Operating mode	
	0	LEDs off
	1...10	Letter display, to be selected with channel 28
	11...21	Number display, to be selected with channel 28
	22...32	Preprogrammed automatic show no. 1

Channel	Value	Function
	33...43	Preprogrammed automatic show no. 2
		⋮
	242...252	Preprogrammed automatic show no. 21
	252...255	Sound-controlled show
28	Selection of the displayed letter (if channel 27 = 1...10)	
	0...9	Letter 'A'
	10...19	Letter 'B'
		⋮
	240...249	Letter 'Y'
	250...255	Letter 'Z'
	Selection of the displayed number (if channel 27 = 11...21)	
	0...27	Number '0'
	28...55	Number '1'

Channel	Value	Function
		:
	224...251	Number '8'
	252...255	Number '9'
	Speed adjustment (if channel 27 = 22...255)	
	0...255	Increasing speed

7.8 Temperature monitoring

The built-in fan turns on automatically as soon as a certain temperature is reached. If a second temperature limit is exceeded despite the turned on fan, the unit automatically switches off. In this case, let the unit cool down before powering it up again.

The temperature-controlled shutoff function is constantly monitored by the device. If a defect is detected, the value 'rt' is flashing in the display. In this case, please contact our service centre. Contact details can be found at www.thomann.de.

8 Technical specifications

Number of DMX channels	1, 4, 26 or 28 channels, according to operating mode
Illuminant	25 × 3 W LEDs (warm white)
Diameter of lenses	9 cm
Dispersion angle	ca. 55°
Operating supply voltage	100 ... 240 V ~ (AC), 50 ... 60 Hz
Power consumption	96 W
Fuse	2.0 A/250 V
Dimensions (W × D × H)	638 mm × 114 mm × 664 mm
Weight	10.2 kg

9 Plug and connection assignments

Introduction

This chapter will help you select the right cables and plugs to connect your valuable equipment so that a perfect light experience is guaranteed.

Please take our tips, because especially in 'Sound & Light' caution is indicated: Even if a plug fits into a socket, the result of an incorrect connection may be a destroyed DMX controller, a short circuit or 'just' a not working light show!

DMX connections

The unit offers a 3-pin XLR socket for DMX output and a 3-pin XLR plug for DMX input. Please refer to the drawing and table below for the pin assignment of a suitable XLR plug.



Pin	Configuration
1	Ground, shielding
2	Signal inverted (DMX-, 'cold signal')
3	Signal (DMX+, 'hot signal')

10 Troubleshooting



NOTICE!

Possible data transmission errors

For error-free operation make use of dedicated DMX cables and do not use ordinary microphone cables.

Never connect the DMX input or output to audio devices such as mixers or amplifiers.

In the following we list a few common problems that may occur during operation. We give you some suggestions for easy troubleshooting:

Symptom	Remedy
The unit does not work, no light	Check the mains connection and the main fuse.
No response to the DMX controller	1. If the first display digit is not flashing in DMX mode, then no valid DMX signal is received. Check that the DMX controller is switched on. Check the DMX connectors and cables for proper connection.
	2. If the first display digit is flashing in DMX mode, but there is still no response, check the address settings and the DMX polarity.
	3. Try using another DMX controller.
	4. Check to see if the DMX cables run near or alongside to high voltage cables that may cause damage or interference to DMX interface circuits.

If the procedures recommended above do not succeed, please contact our Service Center. You can find the contact information at www.thomann.de.

11 Cleaning

Optical lenses

Clean the exterior of accessible optical lenses periodically to optimise light output. The frequency of cleaning depends on the operating environment: wet, smoky or particularly dirty surroundings can cause more accumulation of dirt on the optics of the device.

- Clean with a soft cloth using normal glass cleaning products.
- Always dry the parts carefully.

Fan grids

The fan grids of the device must be cleaned on a regular basis to remove dust and dirt. Before cleaning, switch off the device and disconnect AC-powered devices from the mains. Use a lint-free damp cloth for cleaning. Never use solvents or alcohol for cleaning.

12 Protecting the environment

Disposal of the packaging material



For the transport and protective packaging, environmentally friendly materials have been chosen that can be supplied to normal recycling.

Ensure that plastic bags, packaging, etc. are properly disposed of.

Do not just dispose of these materials with your normal household waste, but make sure that they are collected for recycling. Please follow the notes and markings on the packaging.

Disposal of your old device



This product is subject to the European Waste Electrical and Electronic Equipment Directive (WEEE). Do not dispose with your normal household waste.

Dispose of this device through an approved waste disposal firm or through your local waste facility. When discarding the device, comply with the rules and regulations that apply in your country. If in doubt, consult your local waste disposal facility.



